

BRAUN



Type HF3000IBK, HF3000IWH

Register your product
www.braunhousehold.com/register

Air Fryer

- DE** Bitte lesen Sie die Sicherheitshinweise (separate Broschüre) sorgfältig und vollständig, bevor Sie das Gerät in Betrieb nehmen.
- EN** Please read safety instructions (separate booklet) carefully and completely before using the appliance.
- FR** Veuillez lire attentivement l'intégralité des instructions de sécurité (livret séparé) avant d'utiliser l'appareil.
- ES** Lea completamente las instrucciones de seguridad (manual separado) con atención antes de utilizar el aparato.
- CA** Si us plau, llegiu les instruccions de seguretat (llibret a part) detingudament i completament abans d'utilitzar l'aparell.
- PT** Leia as instruções de segurança (folheto separado) atentamente e por completo antes de utilizar o aparelho.
- IT** Si prega di leggere attentamente ed integralmente le istruzioni di sicurezza (libretto separato) prima di utilizzare l'apparecchio.
- NL** Lees de veiligheidsaanzwijzingen (afzonderlijk boekje) aandachtig en volledig voordat u dit product gebruikt.
- DK** Læs sikkerhedsinstruktionerne (separat hæfte) omhyggeligt og fuldstændigt, før apparatet bruges.
- NO** Les alle sikkerhetsanvisningene grundig før du tar i bruk apparatet.
- SE** Läs igenom säkerhetsanvisningarna (separat häfte) noggrant innan du använder apparaten.
- FI** Lue turvallisuuohjeet (erillinen kirjanen) huolella kokonaan ennen laitteen käyttöä.
- PL** Przed użyciem urządzenia proszę uważnie przeczytać instrukcje bezpieczeństwa (osobna broszura).
- CZ** Přečtěte si pečlivě a kompletně bezpečnostní pokyny (samostatná brožura) před použitím přístroje.
- SK** Kým začnete spotrebič používať, dôkladne si preštudujte bezpečnostné pokyny (samostatná brožúrka).
- HU** Kérjük, hogy a készülék használatá elött olvassa végig figyelmesen a biztonsági utasításokat (külön füzet).
- HR** Molimo vas da prije početka korištenja uređaja pažljivo i u cijelosti pročitate sigurnosne upute (posebna knjižica).
- SL** Pred napravo začnete uporabljati, pozorno in v celoti preberite navodila (ločena knjižica).
- TR** Cihazı kullanmadan önce lütfen güvenli talimatlarını dikkatle ve tamamen okuyun (ayrı kitapçık).
- RO** Vă rugăm să citiți cu atenție și în întregime instrucțiunile de siguranță (broșură separată) înainte de a utiliza aparatul.
- GR** Μελετήστε με προσοχή όλες τις οδηγίες ασφαλείας (ξεχωριστό φυλλάδιο) προτού χρησιμοποιήσετε τη συσκευή.
- KZ** Аспапты Болданарды; алдында 5ауыпсіздік бойынша нЕс5ауларды (бФлек кітапша) зейін 5ойып тігелдей обып шыны;ыз.
- RU** Перед использованием прибора внимательно полностью прочтите инструкции по технике безопасности (отдельная брошюра).
- UA** Перед використанням пристрою уважно та повністю прочитайте інструкцію з техніки безпеки (окрему брошуру).
- AR** يُرجى قراءة تعليمات الأمان (كتيب منفصل) بعناية وبشكل كامل قبل استخدام الجهاز.

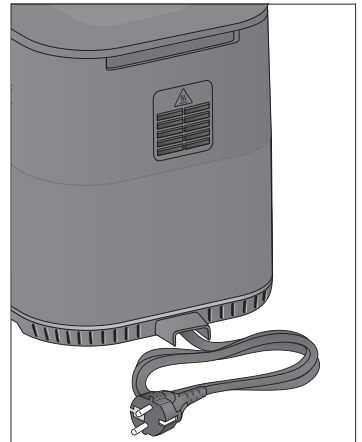
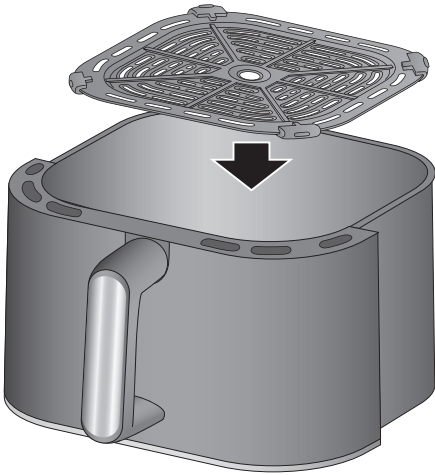
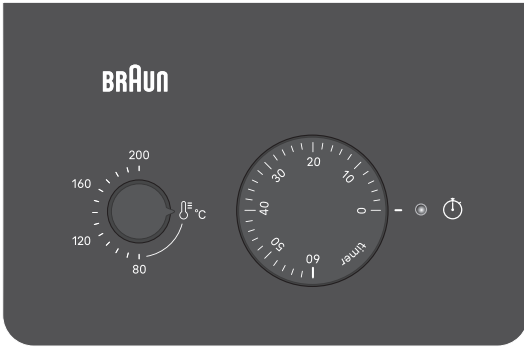

220-240 V~ 50-60 Hz 1500 W

A

1st 

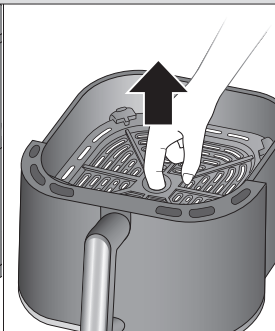
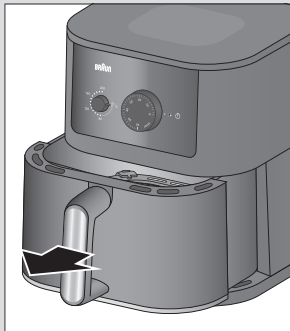

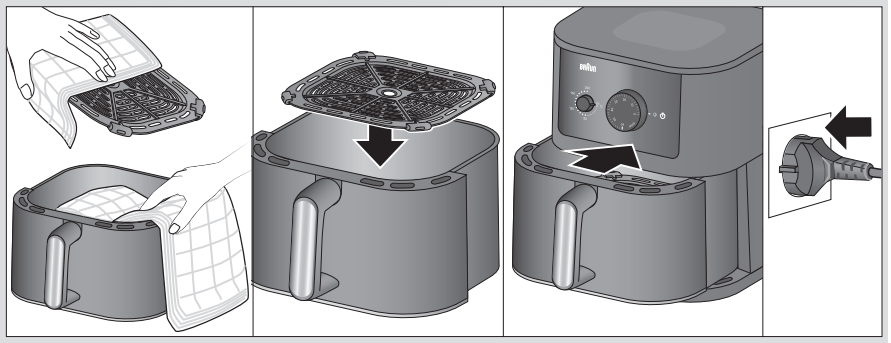

B

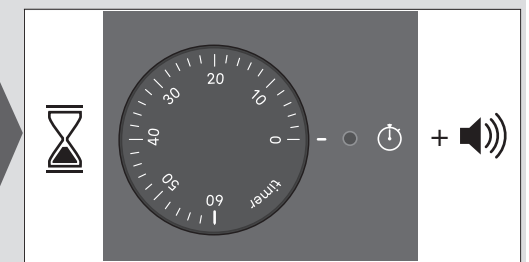
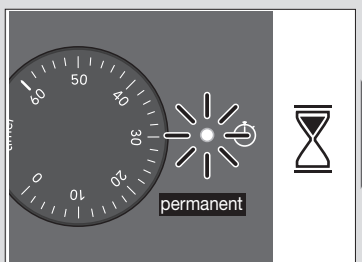
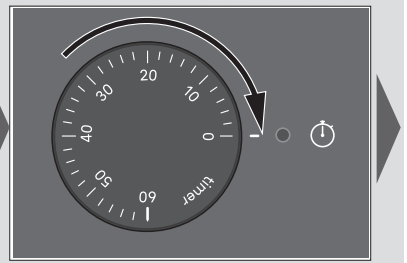
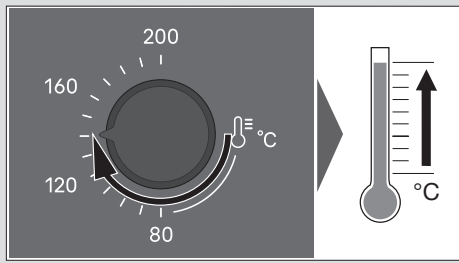

C

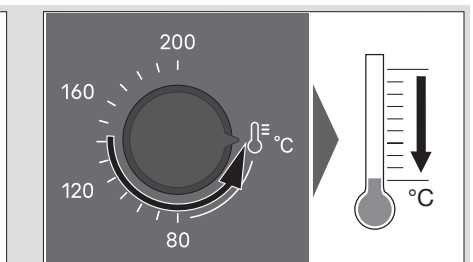
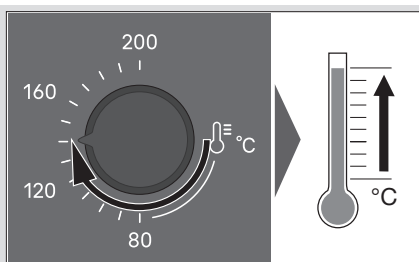
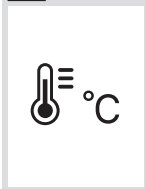



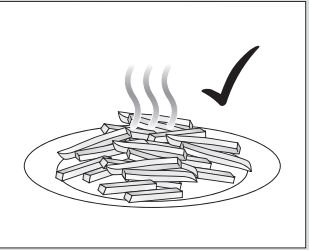
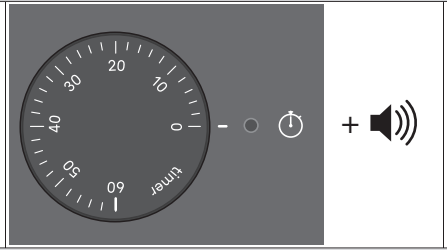
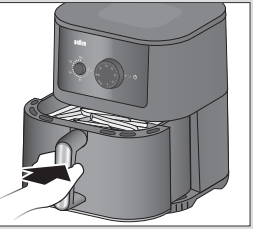
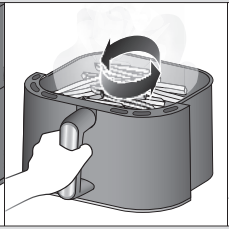
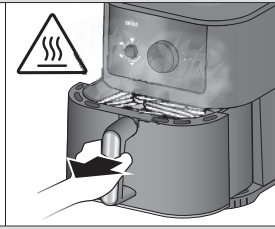
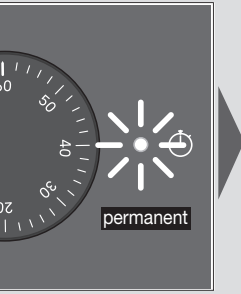
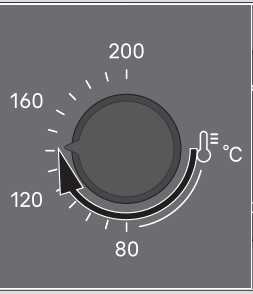
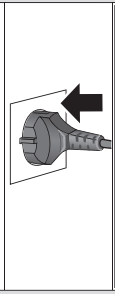
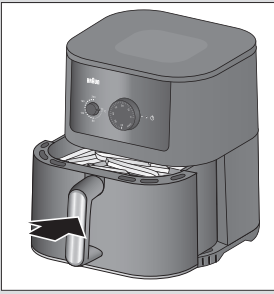
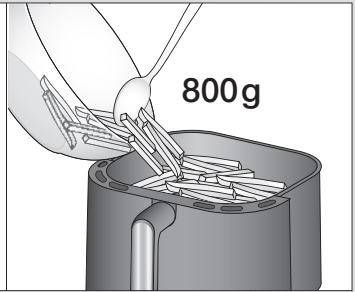
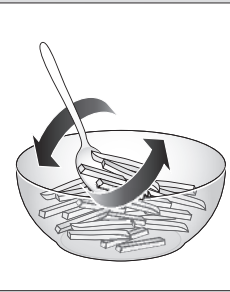
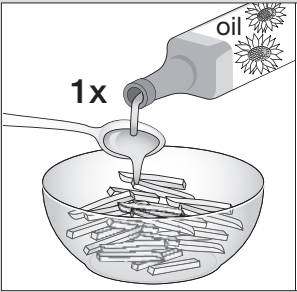
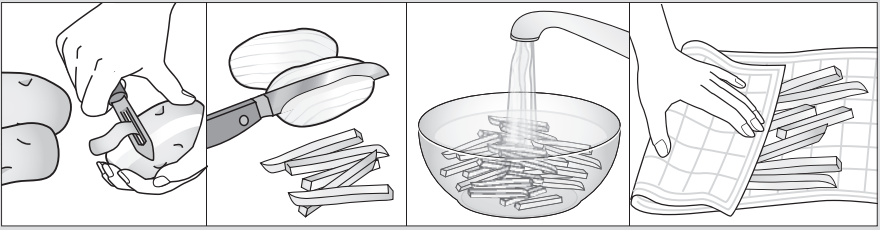



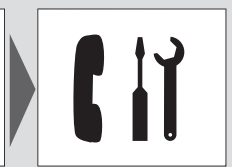
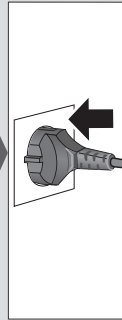
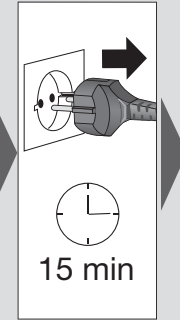
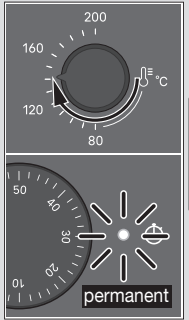
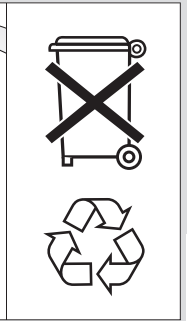
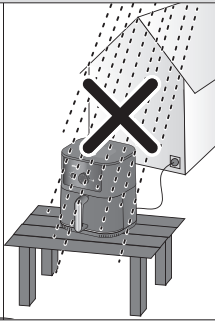







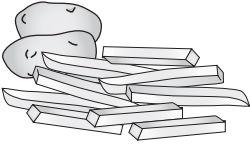
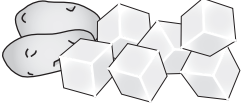
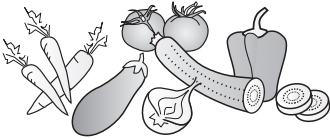

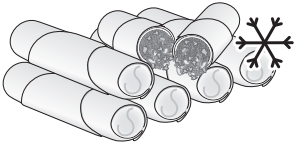







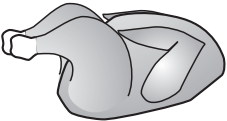

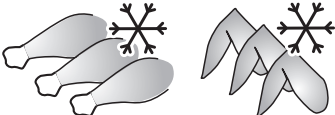

D





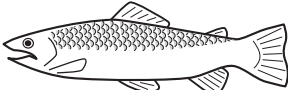
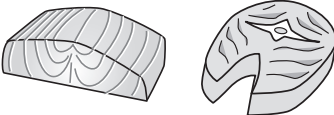
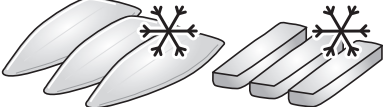

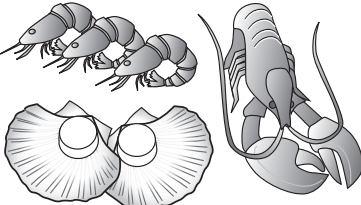









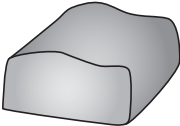

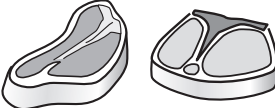

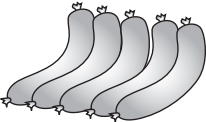



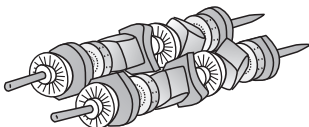

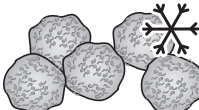



E

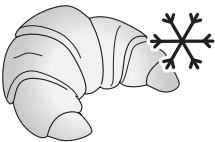
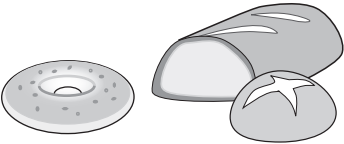

		 g	 min.	 °C		
	7x7 mm	200 - 1000	10 - 27	180	✓	10 min
	10x10 mm	200 - 1000	10 - 28	180	✓	10 min
		200 - 1000	8 - 26	180	✓	10 min
	10x10 mm	500 - 1000	20 - 32	180	✓	10 min
	25x25 mm	500 - 1000	16 - 35	180	✓	10 min
		300 - 800	12 - 25	180	✗	50% 
		400 - 500	8 - 10	180	✓	50% 

	 g	 min.	 °C		
	1000 - 1200	50 - 60	200	✓	50% 
	600 - 700	10 - 12	200	✓	50% 
	400 - 500	10 - 12	200	✓	50% 
	400 - 500	10 - 12	200	✓	50% 
	600 - 800	25 - 30	200	✓	50% 
	300 - 400	20 - 25	180	✓	
	400 - 500	20 - 25	180	✓	
	300 - 400	10 - 12	200	✓	50% 
	500 - 700	10 - 15	180	✗	50% 

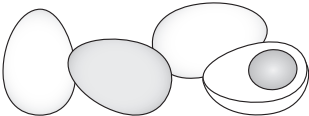
	 g	 min.	 °C		
	400 - 500	12 - 15	180	✓	50% 
	1000	55 - 60	180	✓	50% 
	250 - 300	10 - 12	180	✓	50% 
 4 - 6 pz	400 - 600	20 - 25	180	✓	50% 
	500 - 600	12 - 15	180	✓	50% 
	500 - 600	20 - 25	180	✓	50% 
	400 - 500	8 - 10	180	✓	50% 
	130 - 150	4 - 6	180	✓	50% 

	 g	 min.	 °C		
 4 pz	250 - 300	18 - 20	160	✓	
	200 - 300	20 - 25	160	✓	
 6 pz	350 - 400	15 - 20	160	✓	
	40 - 60	8 - 10	200	✗	
	2 - 8 	13 - 15	130	✓	

F

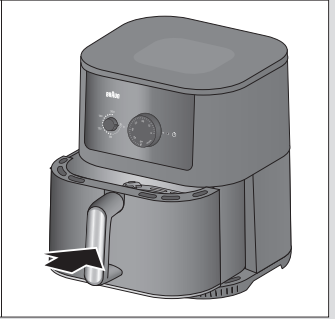
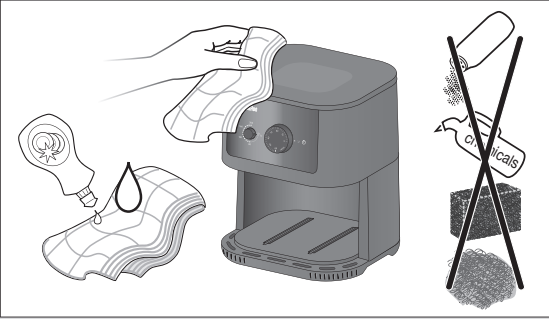
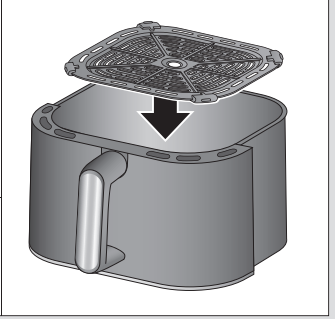
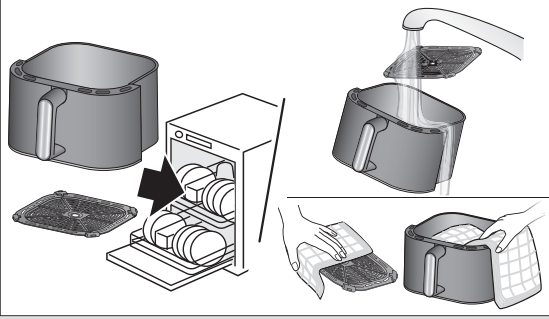
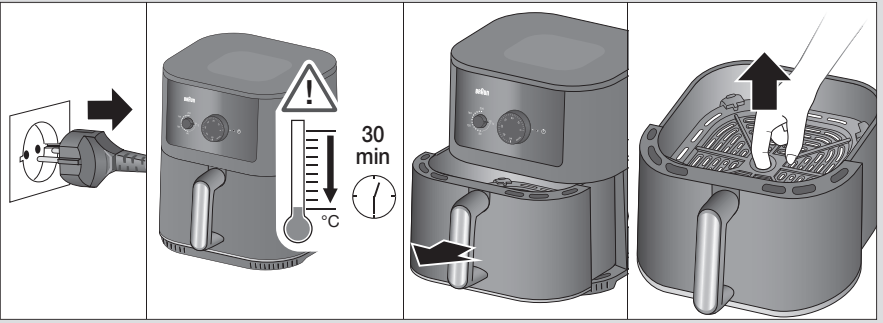

КК
EAC

Үлгі	HF3000
Кернеу	220 – 240 В
Герц	50 – 60 Гц
Ватт	1500 Вт
Сақтау шарттары:	температура: -10°C және +50°C Ылғалдылық: < 90%

Қытайда жасалған

Делонги Браун Хаусхолд ГмБХ
Германия Заңды өндіруші:
Делонги Браун Хаусхолд ГмБХ
Карл-Улрих-Штрассе 4
63263 Ной-Изенбург

Бұйымды іске пайдалану нұсқаулығына сәйкес өз

мақсатында пайдалану керек. Бұйымның қызмет

мерзімі тұтынушыға сатылған күннен бастап 2 жылды құрайды.

Импортер:

«Делонги» ААҚ, Ресей, 127055,
Москва қаласы, Суцёвская көшесі,
27/3-үй (27-үй, 3-құрылым)
Тел. +7 (495) 781-26-76

Сақталу мерзімі: Шектелмеген

Арылу жағдайлары: Қоршаған ортаны қорғау талаптарына сәйкес

Тасымалдау жағдайлары: Тасымалдау кезінде құлатып алуға немесе шамадан тыс шайқалтуға болмайды.

Сату жағдайлары: Сату жағдайларын өндіруші көрсетпеген, бірақ олар жергілікті, мемлекеттік және халықаралық ережелер мен стандарттарға сай болуға тиіс

Өндіруші зауыт:

De'Longhi Braun Household GmbH,
Carl-Ulrich-Strasse 4,
63263 Neu Isenburg, Germany

RU
EAC

Модель	HF3000
Напряжение	220 – 240 В
Частота колебаний	50 – 60 Гц
Мощность	1500 Вт
Условия хранения:	При температуре: от -10°C до +50°C и влажности: < 90%

Изготовлено в Китае для

Де' Лонги Браун Хаусхолд ГмБХ Германия
De'Longhi Braun Household GmbH
Carl-Ulrich-Straße 4
63263 Neu-Isenburg/Germany

Изделие использовать по назначению в соответствии с руководством по эксплуатации.

Срок службы изделия составляет 2 года с даты продажи потребителю.

Импортер и ответственный за претензии потребителей: ООО «Делонги», Россия, 127055, Москва, ул. Суцёвская, д. 27, стр. 3. Тел. +7 (495) 781-26-76

Срок хранения: Не ограничен

Условия утилизации: Утилизировать в соответствии с экологическими требованиями

Условия транспортировки: Во время транспортировки, не бросать и не подвергать излишней вибрации.

Условия реализации: Правила реализации товара не установлены изготовителем, но должны соответствовать региональным, национальным и международным нормам и стандартам.

Производитель:

De'Longhi Braun Household GmbH,
Carl-Ulrich-Strasse 4,
63263 Neu Isenburg, Germany